



Ceramic/Impressions®

Vanity Top Bathroom Sink

K-2791-1

Features

- Integrated sink and vanity top.
- Single faucet hole.
- Oval basin.
- Overflow drain.
- Raised outer edge helps contain water and prevents items from rolling off the vanity top.
- Dimensional colors.
- Coordinates with the industry-standard 24-inch vanities in the KOHLER® Tailored vanity collection.

Material

- Vitreous china.

Installation

- Vanity top.



Codes/Standards







ASME A112.19.2/CSA B45.1

KOHLER® One-Year Limited Warranty

See website for detailed warranty information.

Available Color/Finishes

Color tiles intended for reference only.

Color	Code	Description
	G81	White Impressions
	G82	Dune Impressions
	G83	Biscuit Impressions
	G85	Sandbar Impressions
	G86	Cashmere Impressions
	G88	Thunder Grey Impressions

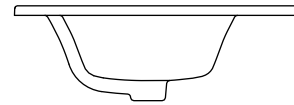
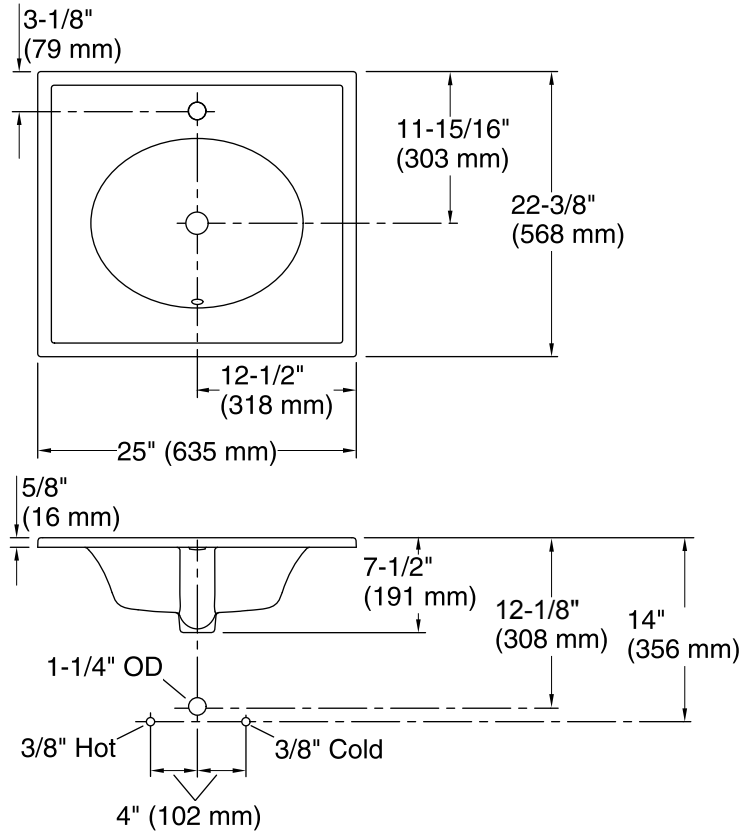

Technical Information

All product dimensions are nominal.

Bowl configuration:	Single
Installation:	ITB
Bowl area (Only):	Length: 17" (432 mm) Width: 13-3/8" (340 mm) Bowl depth: 5-1/2" (140 mm) With overflow: Yes Water depth: 4" (102 mm)
Number of deck holes:	1
Faucet hole(s):	1-3/8" (35 mm)
Drain hole:	1-3/4" (44 mm)

Notes

Install this product according to the installation instructions.

This sink is designed to be installed as an integrated vanity top to a KOHLER or standard vanity.