



# Underscore® Rectangle

60" x 36" Heated BubbleMassage™ air bath with Bask™  
K-1849-GHW

## Features

- 122 airjets release thousands of heated bubbles that surround, support, and massage the body.
- Variable-speed blower lets you adjust massage intensity to 18 levels.
- Bask® heated surface creates spa-like relaxation with soothing warmth on your back, shoulders, and neck.
- Built-in heater.
- Automatic and manual purge cycles remove residual water from air channels after use.
- 60-minute automatic shutoff timer.
- Slotted overflow allows for deep soaking.
- Integral lumbar support.
- Keypad control.
- Textured bottom surface.
- Bask® heated surface creates spa-like relaxation with soothing warmth on your back, shoulders, and neck.

## Material

- Acrylic.

## Technology

- Heated BubbleMassage™ technology warms and humidifies air before it enters the bath.

## Installation

- Drop-in or undermount.
- Reversible drain.
- 120V electrical requirement allows for easy installation with standard outlet.
- Requires two dedicated circuits.

## Required Products/Accessories

K-7271 Brass Slotted Overflow Bath Drain

or

K-7272 PVC Slotted Overflow Bath Drain

## Recommended Products/Accessories

- K-1491 Bath/Whirlpool Pillow
- K-1601 Bath/Whirlpool Footstop
- K-1703 Whirlpool Remote Control
- K-531 Under-Mount Installation Kit
- K-24916 Wireless Music Kit
- K-706000-D3 Frameless Sliding Bath Door
- K-706000-L Frameless Sliding Bath Door
- K-706003-L Frameless Sliding Bath Door
- K-706004-D3 Frameless Sliding Bath Door
- K-706004-L Frameless Sliding Bath Door
- K-706007-L Frameless Sliding Bath Door
- K-1177 Vinyl Tiling-in Bead



## Codes/Standards







ASME A112.19.7/CSA B45.10  
CSA B45.5/IAPMO Z124  
ASTM E162  
ASTM E662  
UL 1795  
CSA C22.2 No. 218.2

**KOHLER® Hydrotherapy Components  
Five-Year Limited Warranty  
KOHLER® Plastic Baths and Receptors  
Lifetime Limited Warranty**

See website for detailed warranty information.

## Available Colors/Finishes

*Color tiles intended for reference only.*

Color	Code	Description
	0	White
	96	Biscuit
	NY	Dune
	95	Ice™ Grey
	58	Thunder™ Grey
	7	Black Black™

1-800-4KOHLER (1-800-456-4537)

Kohler Co. reserves the right to make revisions without notice to product specifications.

For the most current Specification Sheet, go to [www.kohler.com](http://www.kohler.com).

9-2-2020 09:16 - US/CA

THE BOLD LOOK  
OF **KOHLER**®



# Underscore® Rectangle

60" x 36" Heated BubbleMassage™ air bath with Bask™

K-1849-GHW

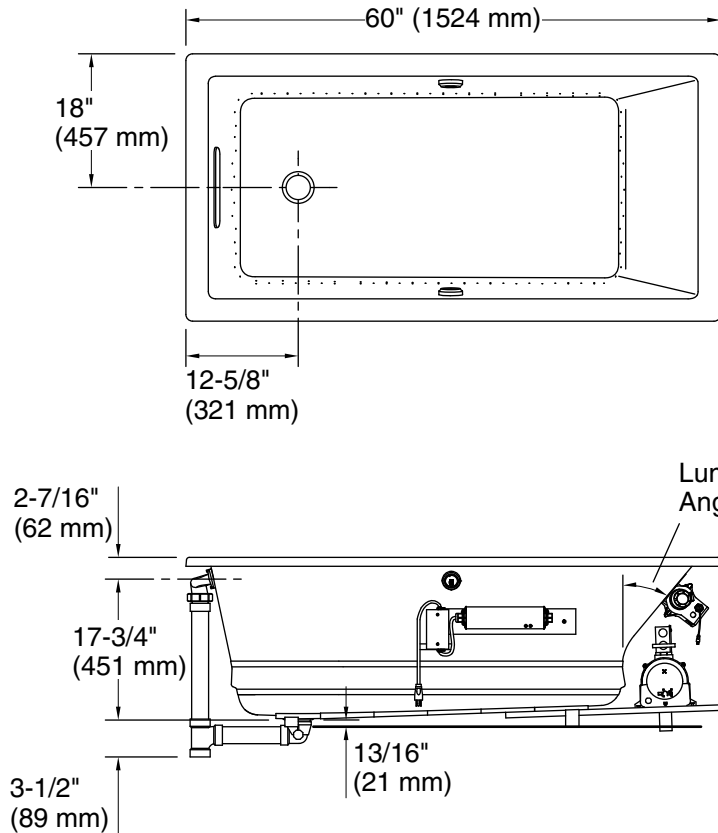

No change in measurements if connected with drain illustrated. (K-7272)

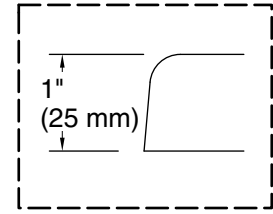

Drop-in Rim Detail

Blower Motor Access  
30" (762 mm) W x 15" (381 mm) H Min

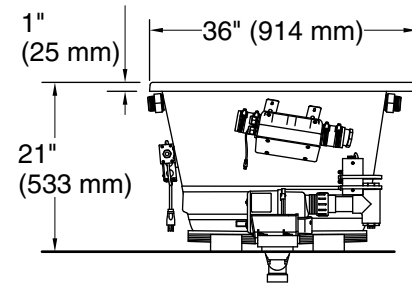

1-1/2" Bath Drain

## Required Electrical Service

Two dedicated circuits required, protected with Class A Ground-Fault Circuit-Interrupter (GFCI). Outside North America, this device may be known as a Residual Current Device (RCD).

Blower, Heated	120 V, 15 A, 60 Hz
Surface:	
Air bath:	120 V, 15 A, 60 Hz

## Notes

Measure your actual product for rough-in details. Install this product according to the installation instructions.

The hot water supply should be 70% of the capacity of the bath or greater. Installations will vary.

## Technical Information

All product dimensions are nominal.

Installation:	Drop-in, Undermount
Drain location:	End
Basin area, bottom:	39-9/16" x 24-11/16" (1005 mm x 627 mm)
Basin area, top:	53-5/8" x 29-1/2" (1362 mm x 749 mm)
Weight:	106 lbs (48.1 kg)
Minimum floor load:	54 lbs/ft <sup>2</sup> (263.7 kg/m <sup>2</sup> )
Water depth:	17-1/8" (435 mm)
Water capacity:	81.1 gal (307 L)
Cutout:	Drop-in, 59-1/2" x 35-1/2" (1511 mm x 902 mm)
Electrical component rating:	Blower: 120 V, 10 A, 60 Hz Heated Surface: 120 V, 0.5 A, 60 Hz, 65

1-800-4KOHLER (1-800-456-4537)

Kohler Co. reserves the right to make revisions without notice to product specifications.

For the most current Specification Sheet, go to [www.kohler.com](http://www.kohler.com).

9-2-2020 09:16 - US/CA

