



Iron/Impressions®

Vanity-top Bathroom Sink

K-3052-8

Features

- 8" (203 mm) centerset faucet holes.
- Elongated oval basin.
- Combines with standard 42-inch vanities to create a complete sink.

Material

- KOHLER® enameled cast iron.

Installation

- Vanity top.

Recommended Products/Accessories

- K-9018 P-Trap
- K-23726 Drain treatment
- K-23725 Cast iron cleaner



Codes/Standards















ASME A112.19.1/CSA B45.2

Lifetime Limited Warranty for KOHLER® Cast Iron Components

See website for detailed warranty information.

Available Colors/Finishes

Color tiles intended for reference only.

Color	Code	Description
	0	White
	FF	Sea Salt™
	96	Biscuit
	NY	Dune
	55	Innocent Blush™
	Y2	Sunlight
	95	Ice™ Grey
	G9	Sandbar
	FT	Basalt
	RR	Ember™
	KA	Black 'n Tan
	7	Black Black™
	GRL	Grey Lavender
	DGB	Indigo Blue
	PLM	Black Plum

1-800-4KOHLE (1-800-456-4537)

Kohler Co. reserves the right to make revisions without notice to product specifications.

For the most current Specification Sheet, go to www.kohler.com.

9-2-2020 13:25 - US/CA

THE BOLD LOOK
OF **KOHLER**®

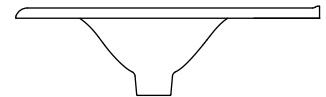
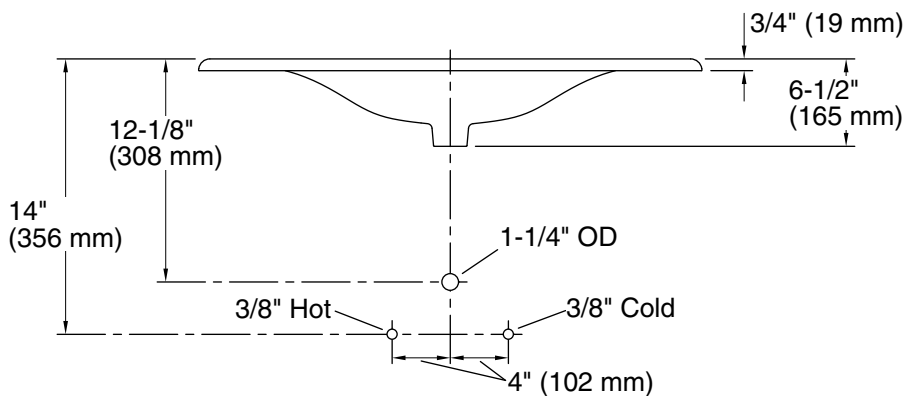
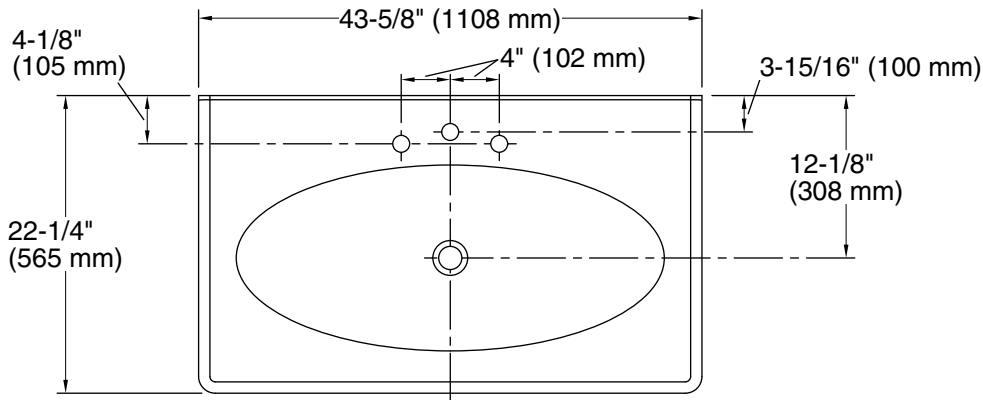

Technical Information

All product dimensions are nominal.

Bowl configuration:	Single
Installation:	Vanity top/ITB
Bowl area (Only):	Length: 32" (813 mm) Width: 13-7/8" (352 mm) Water depth: 4-1/2" (114 mm)
Number of deck holes:	3
Faucet hole spacing:	8" (203 mm)
Faucet hole(s):	1-3/8" (35 mm)
Drain hole:	1-3/4" (44 mm)

Notes

Install this product according to the installation instructions.

NOTE: When selecting a faucet for this bathroom sink, ensure the faucet has a spout reach of 4-1/2" (114 mm) to 5" (127 mm) and has a spout height of 3" (76 mm) to 6" (152 mm).

Product does not have an overflow.