



Iron/Impressions®

Vanity-top Bathroom Sink
K-3053-1

Features

- Single faucet hole.
- Elongated oval basin.
- Combines with standard 48-inch vanities to create a complete sink.

Material

- KOHLER® enameled cast iron.

Installation

- Vanity top.

Recommended Products/Accessories

- K-9018 P-Trap
- K-23726 Drain treatment
- K-23725 Cast iron cleaner



Codes/Standards











ASME A112.19.1/CSA B45.2

Lifetime Limited Warranty for KOHLER® Cast Iron Components

See website for detailed warranty information.

Available Colors/Finishes

Color tiles intended for reference only.

Color	Code	Description
	0	White
	FF	Sea Salt™
	96	Biscuit
	NY	Dune
	95	Ice™ Grey
	FT	Basalt
	KA	Black 'n Tan
	7	Black Black™
	GRL	Grey Lavender
	DGB	Indigo Blue
	PLM	Black Plum

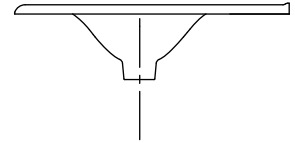
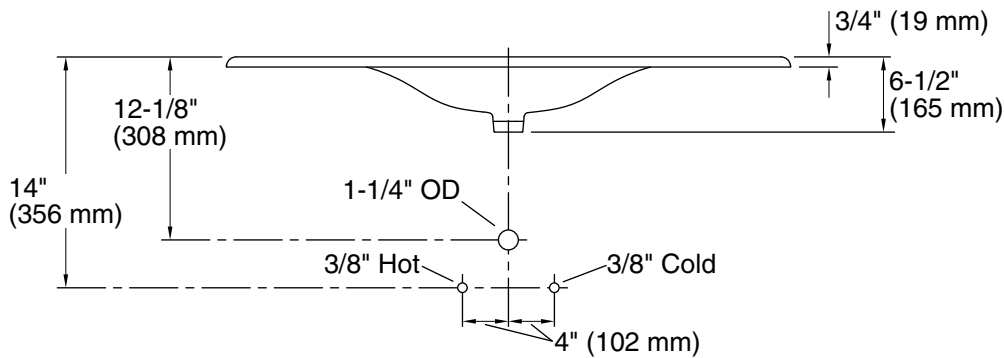
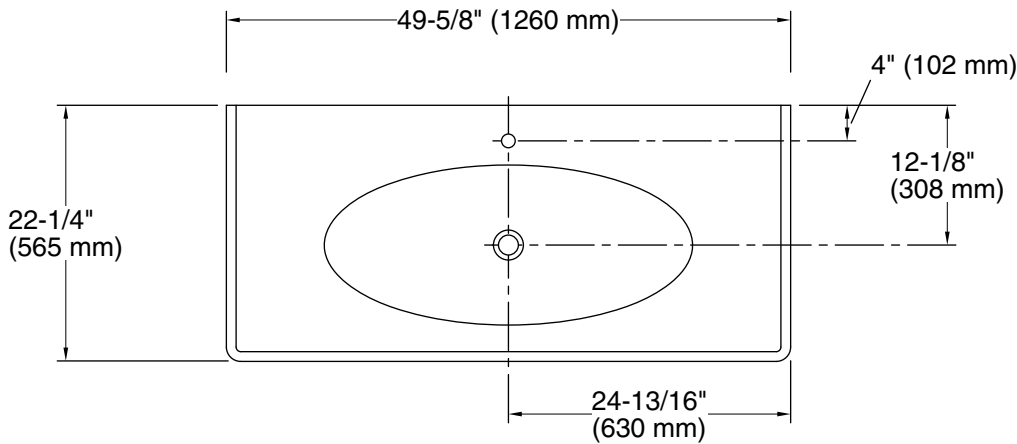

Technical Information

All product dimensions are nominal.

Bowl configuration:	Single
Installation:	Vanity top/ITB
Bowl area (Only):	Length: 32" (813 mm) Width: 13-7/8" (352 mm) Water depth: 4-1/2" (114 mm)
Number of deck holes:	1
Faucet hole(s):	1-3/8" (35 mm)
Drain hole:	1-3/4" (44 mm)

Notes

Install this product according to the installation instructions.

Product does not have an overflow.

NOTE: When selecting a faucet for this bathroom sink, ensure the faucet has a spout reach of 4-1/2" (114 mm) to 5" (127 mm) and has a spout height of 3" (76 mm) to 6" (152 mm).