



# Ceramic/Impressions®

## Vitreous Top and Basin Bathroom Sink

### K-2891-8

#### Features

- Integrated sink and vanity top.
- 8" (203 mm) centerset faucet holes.
- Oval basin.
- Overflow drain.
- Raised outer edge helps contain water and prevents items from rolling off the vanity top.
- Dimensional colors.
- Coordinates with the industry-standard 48-inch vanities in the KOHLER® Tailored vanity collection.

#### Material

- Vitreous china.

#### Installation

- Vanity top.

#### Recommended Products/Accessories

- K-23726 Drain treatment
- K-23725 Cast iron cleaner



#### Codes/Standards







ASME A112.19.2/CSA B45.1

#### KOHLER® One-Year Limited Warranty

See website for detailed warranty information.

#### Available Colors/Finishes

*Color tiles intended for reference only.*

Color	Code	Description
	0	White
	G81	White Impressions
	G82	Dune Impressions
	G83	Biscuit Impressions
	G85	Sandbar Impressions
	G86	Cashmere Impressions
	G88	Thunder Grey Impressions

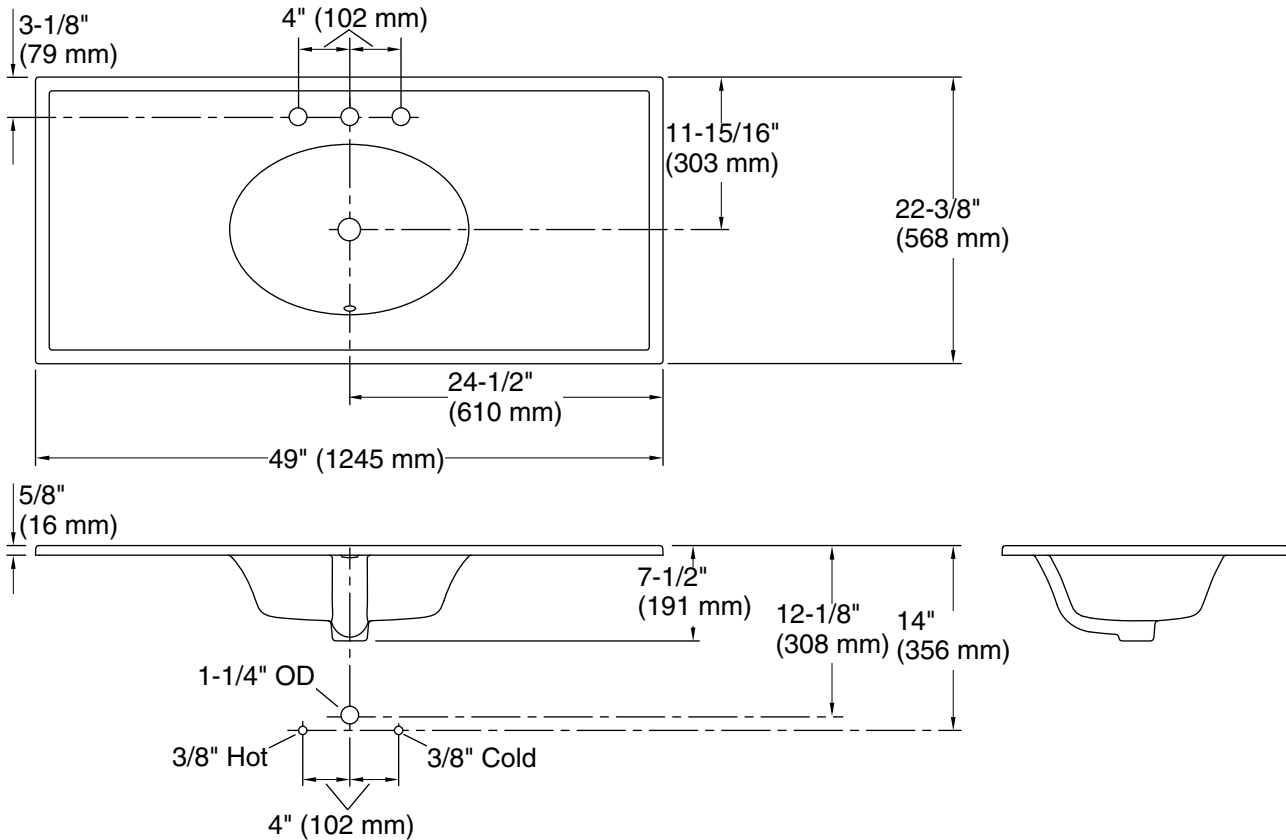

### Technical Information

All product dimensions are nominal.

Bowl configuration:	Single
Installation:	Vanity top/ITB
Bowl area (Only):	Length: 19" (483 mm) Width: 13-3/8" (340 mm) Bowl depth: 5-1/2" (140 mm) With overflow: Yes Water depth: 4" (102 mm)
With overflow:	Yes
Number of deck holes:	3
Faucet hole spacing:	8" (203 mm)
Faucet hole(s):	1-3/8" (35 mm)
Drain hole:	1-3/4" (44 mm)

### Notes

Install this product according to the installation instructions.

This sink is designed to be installed as an integrated vanity top to a KOHLER or standard vanity.