

### Features

- 24-inch minimum base cabinet width.
- Single bowl.
- 9-inch depth.
- No faucet holes.

### Material

- KOHLER® enameled cast iron.

### Installation

- Under-mount

### Recommended Accessories

- K-8801 Sink Strainer
- K-8799 Sink Strainer



ADA

### Codes/Standards















ASME A112.19.1/CSA B45.2  
ADA  
ICC/ANSI A117.1

### KOHLER® Enameled Cast Iron Kitchen Sink Lifetime Limited Warranty

See website for detailed warranty information.

### Available Color/Finishes

*Color tiles intended for reference only.*

Color	Code	Description
	0	White
	FF	Sea Salt™
	96	Biscuit
	47	Almond
	FD	Cane Sugar™
	NY	Dune
	95	Ice™ Grey
	G9	Sandbar
	K4	Cashmere
	FT	Basalt
	58	Thunder™ Grey
	KA	Black 'n Tan
	FP	Caviar
	7	Black Black™

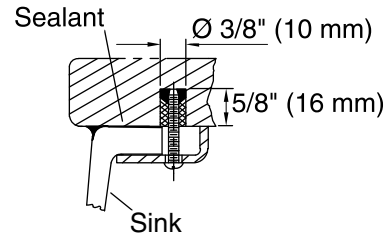
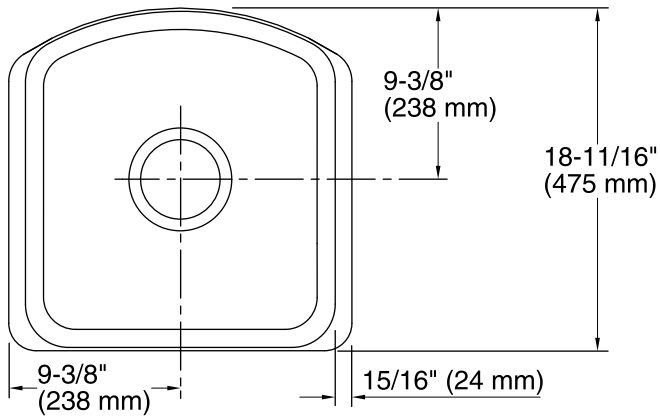

**Solid-Surface  
Installation**

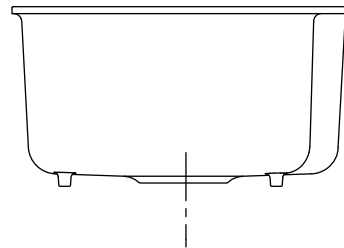
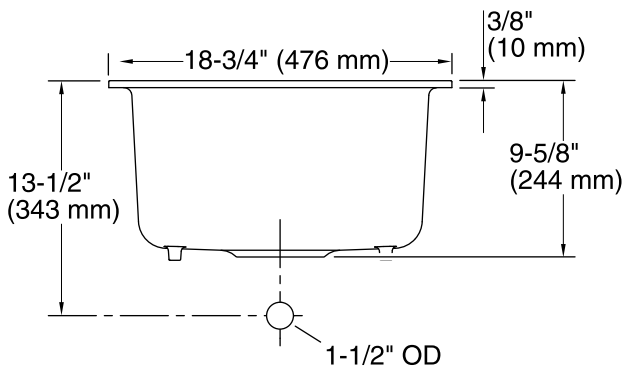

### Technical Information

All product dimensions are nominal.

Installation:	Under-mount
Bowl area:	Length: 15-11/16" (399 mm) Width: 17-1/8" (435 mm) Bowl depth: 9" (229 mm) Water depth: 9" (229 mm)
Template:	1259678-7, required, included

### Notes

Install this product according to the installation instructions.

ADA compliant when installed to the specific requirements of these regulations.