



Features

- Bask® heated surface creates spa-like relaxation with soothing warmth on your back and neck.
- Three heat settings allow you to customize the surface temperature.
- Comfort Depth® design offers a convenient 19-inch step-over height while retaining the same depth as a standard 21-inch bath.
- Molded lumbar support offers extra comfort while bathing.
- Slotted overflow allows for deep soaking.
- Textured bottom surface.
- Reversible drain.
- Coordinates with other products in the Archer collection.

Material

- Acrylic

Installation

- Drop-in

Additional Hydrotherapy Options

- Soaking Bath - K-1948-0
- Soaking Bath + Bask heated surface - K-1948-W1
- BubbleMassage air bath - K-1949-G
- BubbleMassage air bath + Bask heated surface - K-1949-GW
- VibrAcoustic - K-1949-VB
- VibrAcoustic + Bask heated surface - K-1949-VBW
- Whirlpool - K-1949-0
- Whirlpool + heater - K-1949-H
- Whirlpool + Bask heated surface - K-1949-W1
- Whirlpool + BubbleMassage air bath - K-1949-XHG

Required Accessories

K-7271 Brass Slotted Overflow Bath Drain

or

K-7272 PVC Slotted Overflow Bath Drain

Recommended Accessories

K-24916 Wireless Music Kit



ADA

Codes/Standards

CSA B45.5/IAPMO Z124

UL 1795

Greenguard UL 2818 - Gold

ADA

ICC/ANSI A117.1

KOHLER® Plastic Baths and Receptors

Lifetime Limited Warranty









KOHLER® Hydrotherapy Components

Five-Year Limited Warranty

See website for detailed warranty information.

Available Color/Finishes

Color tiles intended for reference only.

Color	Code	Description
	0	White
	96	Biscuit
	47	Almond
	NY	Dune
	95	Ice™ Grey
	G9	Sandbar
	K4	Cashmere
	58	Thunder™ Grey

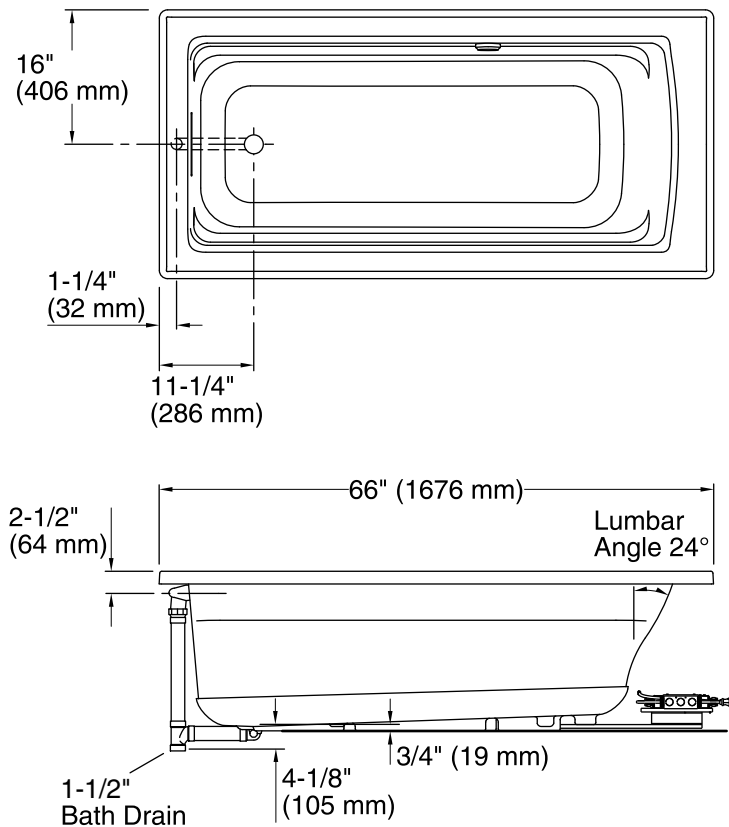

No change in measurements if connected with drain illustrated. (K-7272)

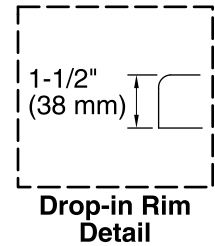

Access Panel
30" (762 mm) W x
15" (381 mm) H

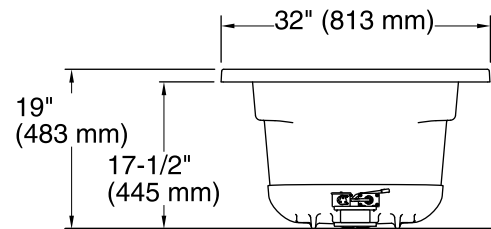

Required Electrical Service

One circuit required, protected with Class A Ground-Fault Circuit-Interrupter (GFCI) or Residual Current Device (RCD).

Heated Surface: 120 V, 15 A, 60 Hz

Technical Information

All product dimensions are nominal.

Installation:	Drop-in
Drain location:	End
Basin area, bottom:	50-3/8" x 19-5/8" (1280 mm x 498 mm)
Basin area, top:	57-5/16" x 24-1/16" (1456 mm x 611 mm)
Weight:	76 lbs (34.5 kg)
Minimum floor load:	45.4 lbs/ft ² (221.7 kg/m ²)
Water depth:	15-5/16" (389 mm)
Water capacity:	66 gal (249.8 L)
Cutout:	Drop-in, 64-1/2" x 30-1/2" (1638 mm x 775 mm)
Electrical component rating:	Heated Surface: 120 V, 0.5 A, 50/60 Hz, 65 W
Minimum flat for door:	2-3/16" (55 mm)

Notes

Measure your actual product for rough-in details. Install this product according to the installation instructions.

The hot water supply should be 70% of the capacity of the bath or greater. Installations will vary.

This product is designed for drop-in installation only. It is not suited for use in a three-wall alcove with an overhead shower.

ADA compliant when installed to the specific requirements of these regulations.