



### Features

- VibrAcoustic calms and soothes with sound vibration technology.
- Six concealed speakers send sound waves through the water to gently massage the body.
- Four original instrumental compositions offer different levels of relaxation.
- Syncs with devices enabled with BLUETOOTH® wireless technology including smartphones, MP3 players, tablets, and laptops located up to 33 feet away.\*
- Customize your experience with the high-resolution color touch screen.
- Fully adjustable volume above and below the water.
- Functions as a hydrotherapy bath when full of water and a stereo system when empty.
- Includes 25 feet of wiring and amplifier.
- Hourglass shape adds style and elegance to your bathroom.
- Integral apron.
- Integral flange helps prevent water from seeping behind wall and simplifies alcove installation.
- Textured bottom surface
- Right-hand drain.
- \*The BLUETOOTH® word mark and logos are registered trademarks owned by Bluetooth SIG, Inc. and any use of such marks by Kohler Co. is under license. Other trademarks and trade names are those of their respective owners.

### Material

- Acrylic

### Hydrotherapy

- VibrAcoustic

### Installation

- Three-wall alcove.
- Requires 110V electrical service.

### Recommended Accessories

1184460 Under-Mount Installation Kit  
 K-1278 Removable Apron  
 K-1491 Bath/Whirlpool Pillow  
 K-1601 Bath/Whirlpool Footstop  
 K-7161-AF Bath Drain  
 K-7259 Clearflo Bath Drain  
 K-37380 30" Rough-in Cable Bath Drain  
 K-37383 30" Rough-in Cable Bath Drain  
 K-37386 30" Rough-in Cable Bath Drain



### Codes/Standards





CSA B45.5/IAPMO Z124  
 ASTM E162  
 ASTM E662  
 UL 1795  
 Greenguard UL 2818 - Gold

### KOHLER® Plastic Baths and Receptors Lifetime Limited Warranty

See website for detailed warranty information.

### Available Color/Finishes

*Color tiles intended for reference only.*

Color	Code	Description
	0	White
	96	Biscuit
	47	Almond
	NY	Dune
	G9	Sandbar

No changes in measurements if connected with drain illustrated. (K-7161-AF)

□ Recommended Faucet Location

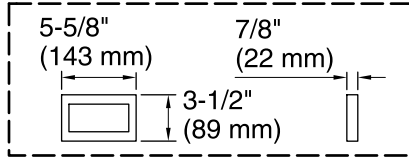

**User Interface**

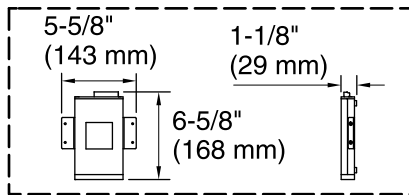

**Amplifier**

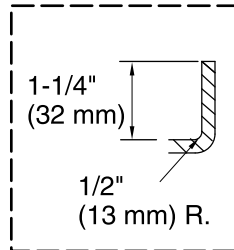

**Flange Detail**

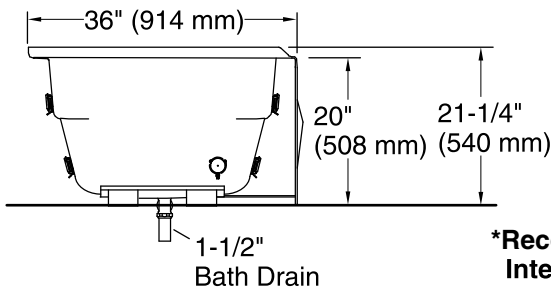

**\*Recommended User Interface Location**

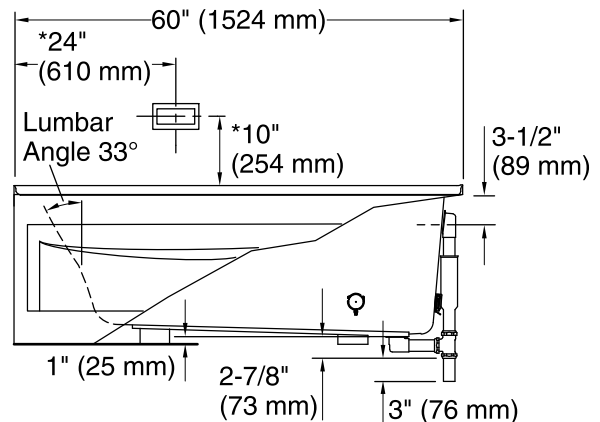
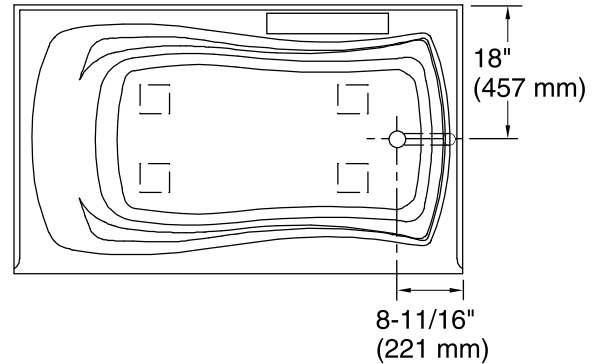

### Required Electrical Service

One circuit required, protected with Class A Ground-Fault Circuit-Interrupter (GFCI) or Residual Current Device (RCD).

Amplifier: 120 V, 15 A, 50/60 Hz

### Technical Information

All product dimensions are nominal.

Installation: 3-Wall Alcove

Drain location: Right

Basin area, bottom: 46" x 24" (1168 mm x 610 mm)

Basin area, top: 54" x 27" (1372 mm x 686 mm)

Weight: 71 lbs (32.2 kg)

Minimum floor load: 42 lbs/ft<sup>2</sup> (205.1 kg/m<sup>2</sup>)

Water depth: 14" (356 mm)

Water capacity: 63 gal (238.5 L)

Electrical component rating: Amplifier: 120 V, 50/60 Hz

Minimum flat for door: 2" (50 mm)

### Notes

Measure your actual product for rough-in details. Install this product according to the installation instructions.

The hot water supply should be 70% of the capacity of the bath or greater. Installations will vary.

Control amplifier fits 16" (406 mm) center studs. 25' (7.6 m) cables are included.

If installing a rim-mount faucet, make sure there is no interference above or below the deck before drilling any holes.