



Inia® Wading Pool®

Vessel Bathroom Sink
K-2773-G3

Features

- Deep rectangular basin in opaque glass with rippled texture.
- No faucet holes; requires wall- or counter-mount faucet.
- Glass material provides a strong, durable surface that is easy to clean.
- The Inia sink is available in clear glass (Ice), Translucent colors, and Opaque colors.
- Opaque color sinks feature a clear glass rim.

Material

- Glass

Installation

- Vessel

Included Components

Additional Components:
1197255



ADA

Codes/Standards

CSA B45.11/IAPMO Z401
ADA
ICC/ANSI A117.1

KOHLER® One-Year Limited Warranty

See website for detailed warranty information.

Available Colors/Finishes

Color tiles intended for reference only.

Color	Code	Description
-------	------	-------------

	B11	Ice
--	-----	-----

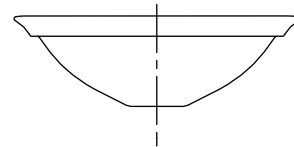
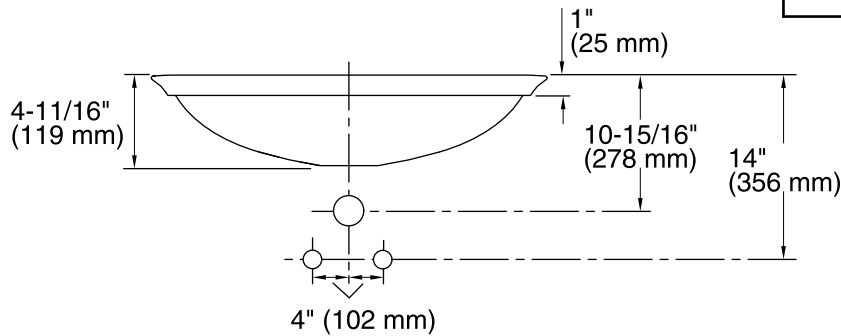
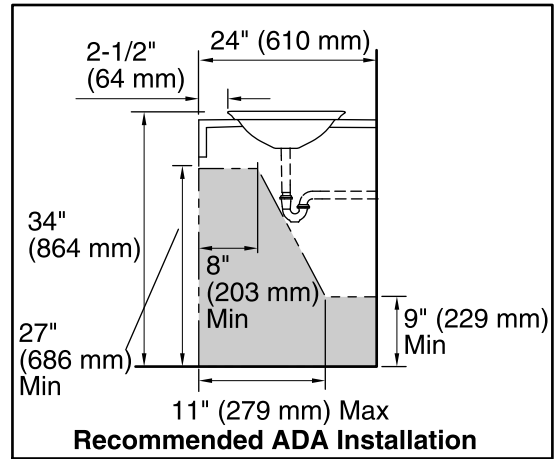
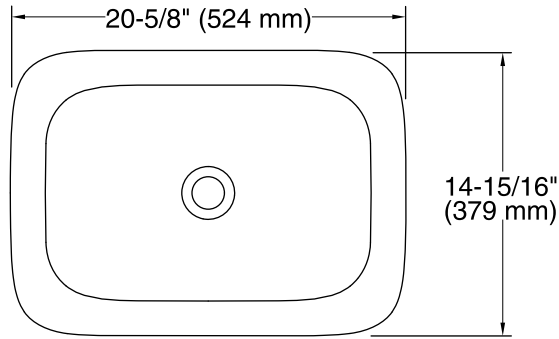

Technical Information

All product dimensions are nominal.

Installation: Vessel

Template: 1190263-7, not required, included

Notes

Install this product according to the installation instructions.

Product does not have an overflow.

NOTICE: Countertop manufacturer or cutter must use the cut-out template provided with the product, or a current one provided by Kohler Co. (call 1-800-4KOHLER). Kohler Co. is not responsible for cut-out errors when the incorrect cut-out template is used.

Product must be installed with the supplied drain gasket kit.

ADA compliant when installed to the specific requirements of these regulations.