

Features

- 36-inch minimum base cabinet width.
- Large/medium bowls.
- 9-inch depth.
- Two faucet holes.
- An integrated faucet deck provides additional water containment.
- Smart Divide® features a lower bowl divider that increases workspace and versatility.
- Includes two bottom sink racks, walnut cutting board, and colander.
- Includes under-mount installation kit for simplified installation.

Material

- KOHLER® enameled cast iron.

Installation

- Under-mount

Recommended Accessories

K-9000 P-Trap
K-6163 Right-Bowl Sink Rack
K-6164 Left-Bowl Sink Rack
K-6377 Sponge Caddy
K-6378 Kitchen Brush Caddy
K-6379 Kitchen Squeegee
K-6383 Soap Dispenser
K-8619 Flexible Kitchen Mat
K-8624 Dish Scraper
K-8801 Sink Strainer
K-8799 Sink Strainer

Components

Product includes:

K-6163 Right-Bowl Sink Rack
K-6164 Left-Bowl Sink Rack
K-6165 Cutting Board
K-6166 Colander
1054375 Under-mount Sink Kit, 23"



Codes/Standards















ASME A112.19.1/CSA B45.2

KOHLER® Enameled Cast Iron Kitchen Sink Lifetime Limited Warranty

See website for detailed warranty information.

Available Color/Finishes

Color tiles intended for reference only.

Color	Code	Description
	0	White
	FF	Sea Salt™
	96	Biscuit
	47	Almond
	FD	Cane Sugar™
	NY	Dune
	95	Ice™ Grey
	G9	Sandbar
	K4	Cashmere
	FT	Basalt
	58	Thunder™ Grey
	KA	Black 'n Tan
	FP	Caviar
	7	Black Black™

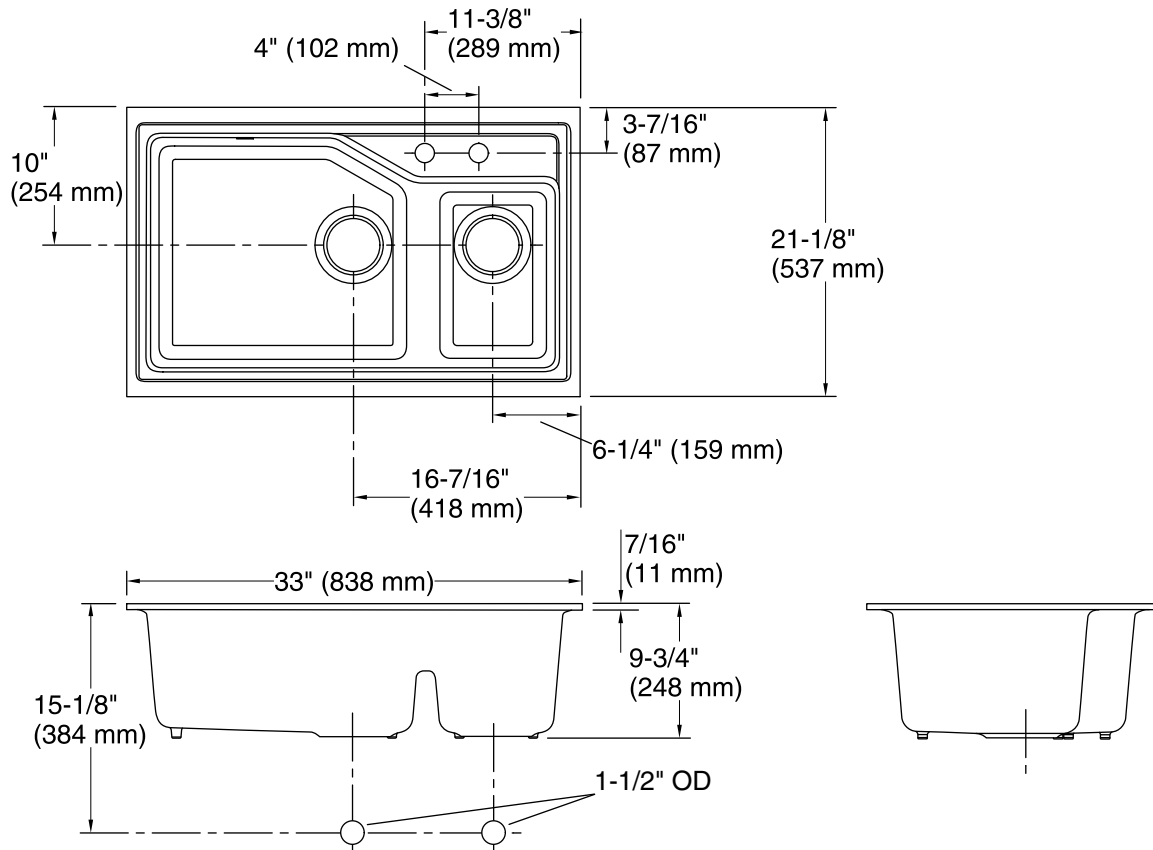

Technical Information

All product dimensions are nominal.

Installation:	Under-mount
Min. base cabinet width:	36" (914 mm)
Bowl area (Left):	Length: 18-15/16" (481 mm) Width: 16-3/4" (425 mm) Bowl depth: 9" (229 mm) Water depth: 9" (229 mm)
Bowl area (Right):	Length: 8-11/16" (221 mm) Width: 13-1/2" (343 mm) Bowl depth: 9" (229 mm) Water depth: 9" (229 mm)
Number of deck holes:	2
Faucet hole(s):	1-3/8" (35 mm)
Drain hole:	3-7/8" (98 mm)
Template:	1106715-7, required, included

Notes

Install this product according to the installation instructions.

NOTICE: The countertop manufacturer or cutter must use the cut-out template provided with the product, or a current one provided by the Kohler Co. (Call 1-800-4-KOHLER.) Kohler Co. is not responsible for cut-out errors when the incorrect cut-out template is used.