



Iron Plains® Capsule

bathroom sink

K-20213-P5

Features

- Elongated oval basin.
- No faucet holes; requires wall- or counter-mount faucet.
- Overflow drain.

Material

- KOHLER® enameled cast iron.
- Painted underside in Iron Black.

Installation

- Vessel, drop-in, or under-mount.



ADA

CSA B651

Codes/Standards

ASME A112.19.1/CSA B45.2

ADA

ICC/ANSI A117.1











CSA B651

Lifetime Limited Warranty for KOHLER® Cast Iron Components

See website for detailed warranty information.

Available Colors/Finishes

Color tiles intended for reference only.

Color	Code	Description
	0	White
	FF	Sea Salt™
	96	Biscuit
	FD	Cane Sugar™
	NY	Dune
	G9	Sandbar
	K4	Cashmere
	FT	Basalt
	KA	Black 'n Tan
	7	Black Black™

1-800-4KOHLE (1-800-456-4537)

Kohler Co. reserves the right to make revisions without notice to product specifications.

For the most current Specification Sheet, go to www.kohler.com.

4-25-2019 19:33 - US/CA

THE BOLD LOOK
OF **KOHLER**®

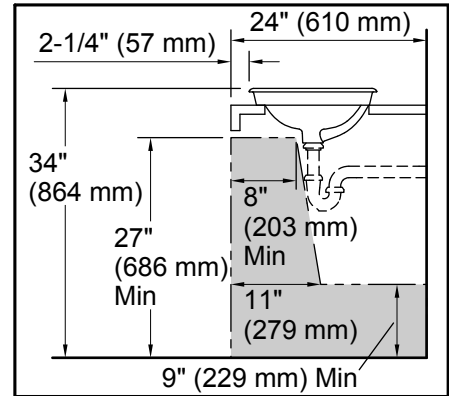
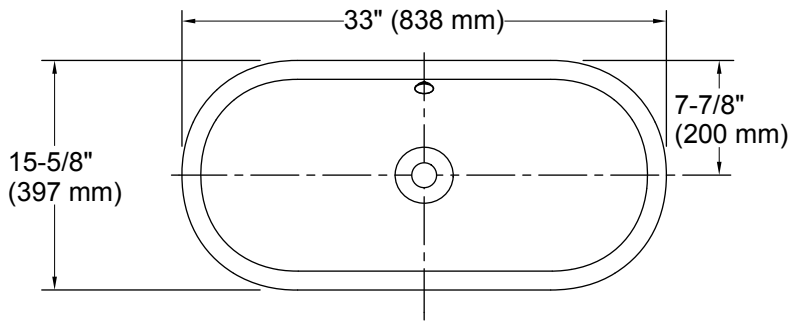

Recommended ADA Installation

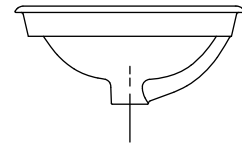
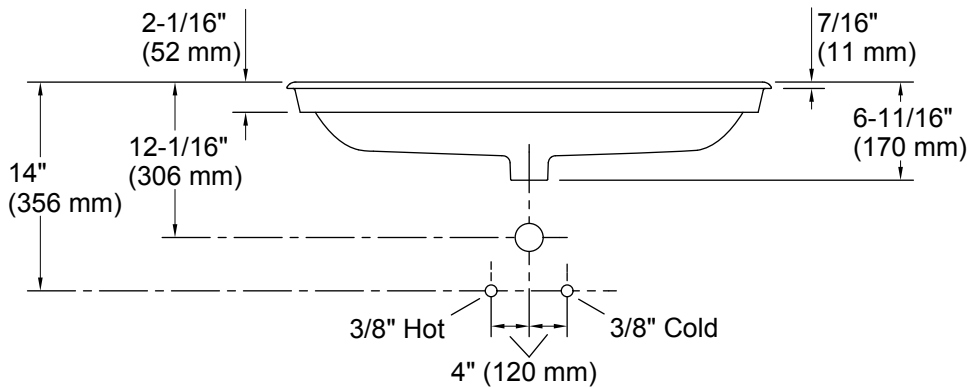

Technical Information

All product dimensions are nominal.

Installation: Drop-in, Under-mount, Vessel

Drain hole: 1-3/4" (44 mm)

Template: 1319049-7, required, included

Notes

Install this product according to the installation instructions.

NOTICE: Countertop manufacturer or cutter must use the cut-out template provided with the product, or a current one provided by Kohler Co. (call 1-800-4-KOHLER). Kohler Co. is not responsible for cutout errors when the incorrect cut-out template is used.

ADA, CSA B651 compliant when installed to the specific requirements of these regulations.