



# Underscore® Rectangle

5' Bath

K-1121-W1



## Features

- Bask® heated surface creates spa-like relaxation with soothing warmth on your back and neck.
- Customize the heat with three adjustable settings.
- Molded lumbar support offers extra comfort while bathing.
- Slotted overflow allows for deep soaking.
- End drain.
- Under-mountable

## Material

- Acrylic

## Installation

- Drop-in or under-mount.
- Requires 110V electrical service.

## Required Accessories

K-7271 Brass Slotted Overflow Bath Drain

or

K-7272 PVC Slotted Overflow Bath Drain

## Recommended Accessories

K-531 Under-Mount Installation Kit

K-1491 Bath/Whirlpool Pillow

K-1601 Bath/Whirlpool Footstop

K-24916 Wireless Music Kit

K-1177 Vinyl Tiling-in Bead



ADA

## Codes/Standards

CSA B45.5/IAPMO Z124

ASTM E162

ASTM E662

Greenguard UL 2818 - Gold

ADA

ICC/ANSI A117.1

## KOHLER® Plastic Baths and Receptors

### Lifetime Limited Warranty









### KOHLER® Hydrotherapy Components

### Five-Year Limited Warranty

See website for detailed warranty information.

## Available Color/Finishes

*Color tiles intended for reference only.*

Color	Code	Description
	0	White
	96	Biscuit
	47	Almond
	NY	Dune
	95	Ice™ Grey
	G9	Sandbar
	K4	Cashmere
	58	Thunder™ Grey

1-800-4KOHLER (1-800-456-4537)

Kohler Co. reserves the right to make revisions without notice to product specifications.

For the most current Specification Sheet, go to [www.kohler.com](http://www.kohler.com).

12-4-2018 09:50 - US/CA

THE BOLD LOOK  
OF **KOHLER**®

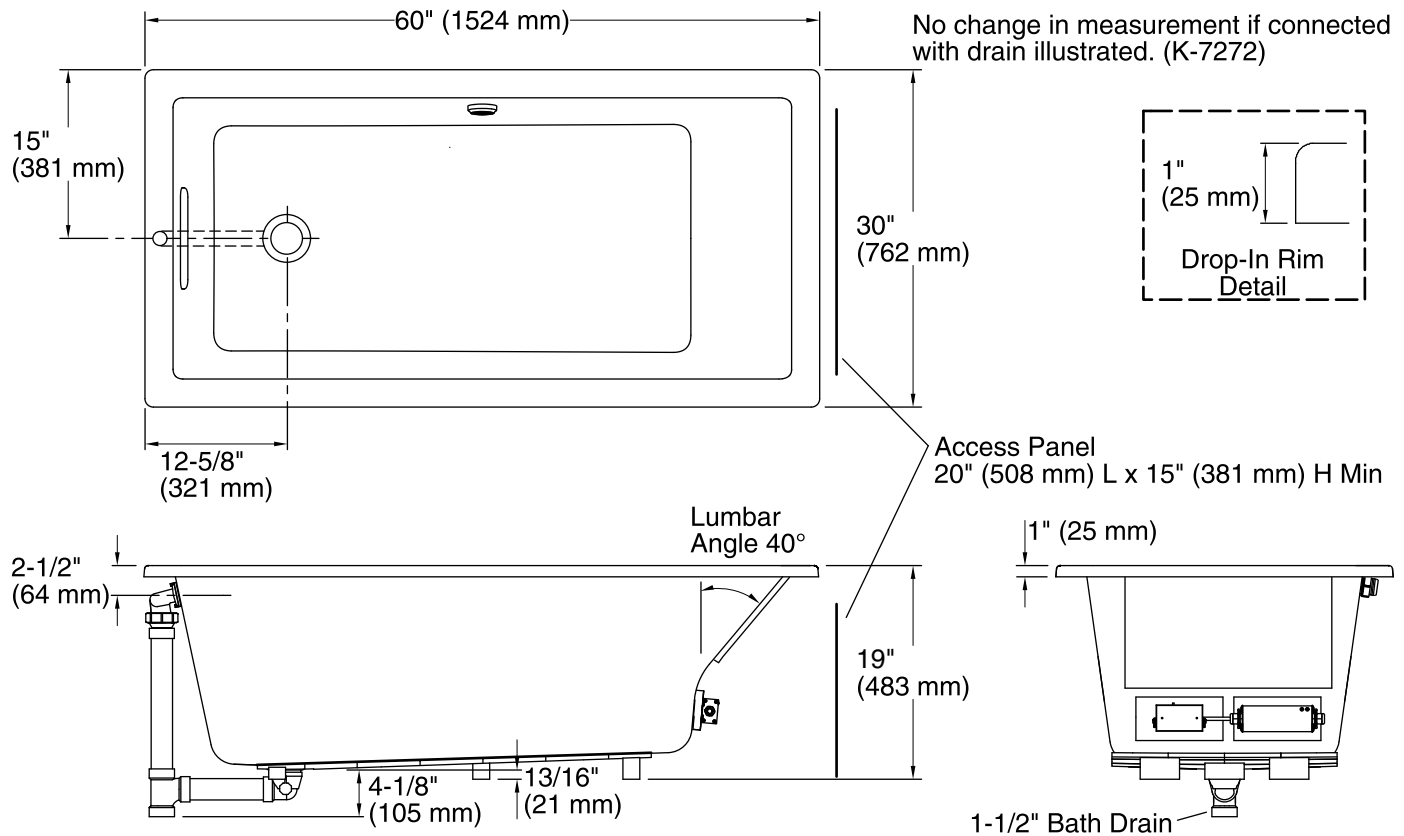

### Required Electrical Service

One circuit required, protected with Class A Ground-Fault Circuit-Interrupter (GFCI) or Residual Current Device (RCD).

Heated Surface: 120 V, 15 A

### Technical Information

All product dimensions are nominal.

Installation:	Drop-in, Under-mount
Drain location:	End
Basin area, bottom:	42-3/8" x 20" (1076 mm x 508 mm)
Basin area, top:	54-3/8" x 24-5/16" (1381 mm x 618 mm)
Weight:	77 lbs (34.9 kg)
Minimum floor load:	50 lbs/ft <sup>2</sup> (244.1 kg/m <sup>2</sup> )
Water depth:	15-1/16" (383 mm)
Water capacity:	59.8 gal (226.4 L)
Cutout:	Drop-in, 59-1/2" x 28-1/2" (1511 mm x 724 mm)
Electrical component rating:	Heated Surface: 120 V, 0.5 A, 60 Hz
Minimum flat for door:	1-15/16" (50 mm)

### Notes

Measure your actual product for rough-in details. Install this product according to the installation instructions.

The hot water supply should be 70% of the capacity of the bath or greater. Installations will vary.

Kit is required for under-mount installations (sold separately).

ADA compliant when installed to the specific requirements of these regulations.