

Features

- Rectangular basin with curved bottom.
- Overflow drain.
- No faucet holes; requires wall- or counter-mount faucet.
- ADA-compliant when installed in a 21" minimum depth countertop

Material

- Vitreous china.

Installation

- Under-mount

Recommended Accessories

K-8998 P-Trap

Components

Additional included component/s: 1193643 Basin Clamps.



ADA

Codes/Standards

ASME A112.19.2/CSA B45.1

ADA











ICC/ANSI A117.1

KOHLER® One-Year Limited Warranty

See website for detailed warranty information.

Available Color/Finishes

Color tiles intended for reference only.

Color	Code	Description
	0	White
	96	Biscuit
	47	Almond
	NY	Dune
	95	Ice™ Grey
	G9	Sandbar
	33	Mexican Sand™
	K4	Cashmere
	58	Thunder™ Grey
	7	Black Black™

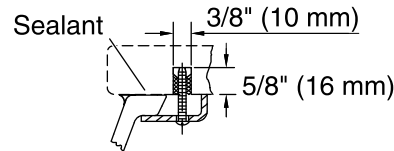
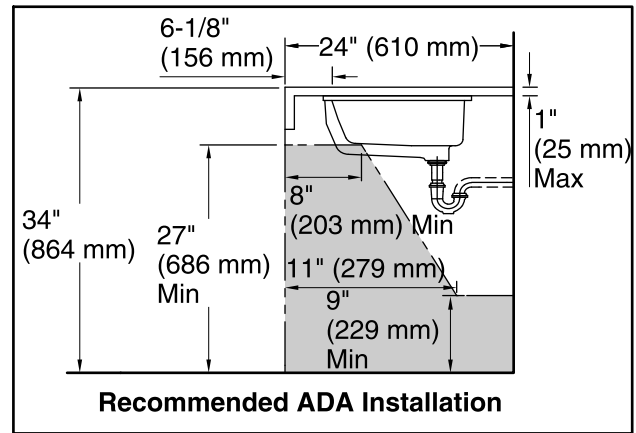
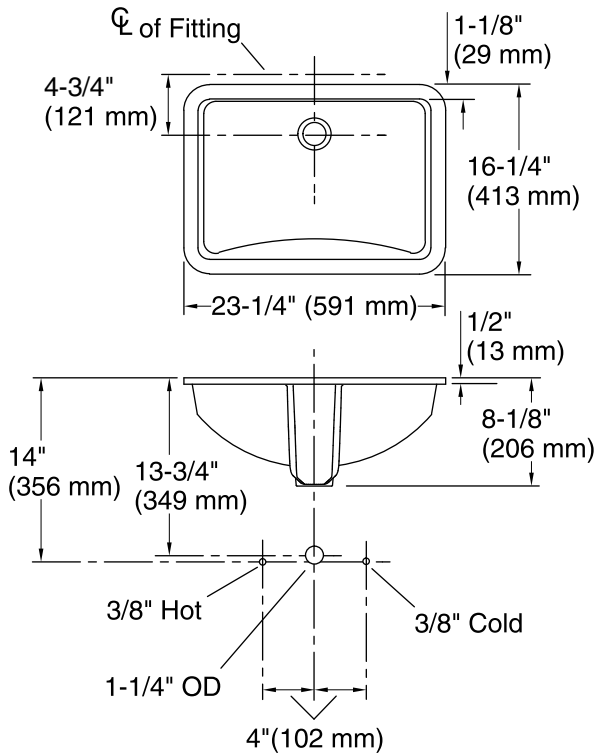

Marble Installation

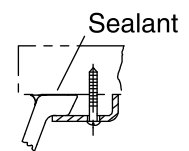

Wood Installation

Technical Information

All product dimensions are nominal.

Installation:	Under-mount
Bowl area:	Length: 20-5/8" (524 mm) Width: 13-5/8" (346 mm) Water depth: 4-5/8" (117 mm)
Drain hole:	1-3/4" (44 mm)
Template:	1002977-7, required, not included

Notes

Install this product according to the installation instructions.

The product diagram is based on the K-8998 adjustable P-trap with 1" (25 mm) of tailpiece exposed.

NOTICE: Countertop manufacturer or cutter must use the current product template available at www.kohler.com, or by calling 1-800-4KOHLER. Kohler Co. is not responsible for cutout errors when the incorrect cutout template is used.

ADA compliant when installed to the specific requirements of these regulations.