

Features

- 33-inch minimum base cabinet width for top-mount installation.
- 36-inch minimum base cabinet width for under-mount
- Double equal bowls.
- 9-inch depth.
- No faucet holes.
- Smart Divide® features a lower bowl divider that increases workspace and versatility.

Material

- KOHLER® enameled cast iron.

Installation

- Top-mount or under-mount.

Recommended Accessories

- K-9000 P-Trap
- K-8801 Sink Strainer
- K-8799 Sink Strainer

Optional Accessories

- K-8339 Sink Rack



Codes/Standards















ASME A112.19.1/CSA B45.2

KOHLER® Enameled Cast Iron Kitchen Sink Lifetime Limited Warranty

See website for detailed warranty information.

Available Color/Finishes

Color tiles intended for reference only.

Color	Code	Description
	0	White
	FF	Sea Salt™
	96	Biscuit
	47	Almond
	FD	Cane Sugar™
	NY	Dune
	95	Ice™ Grey
	G9	Sandbar
	K4	Cashmere
	FT	Basalt
	58	Thunder™ Grey
	KA	Black 'n Tan
	FP	Caviar
	7	Black Black™

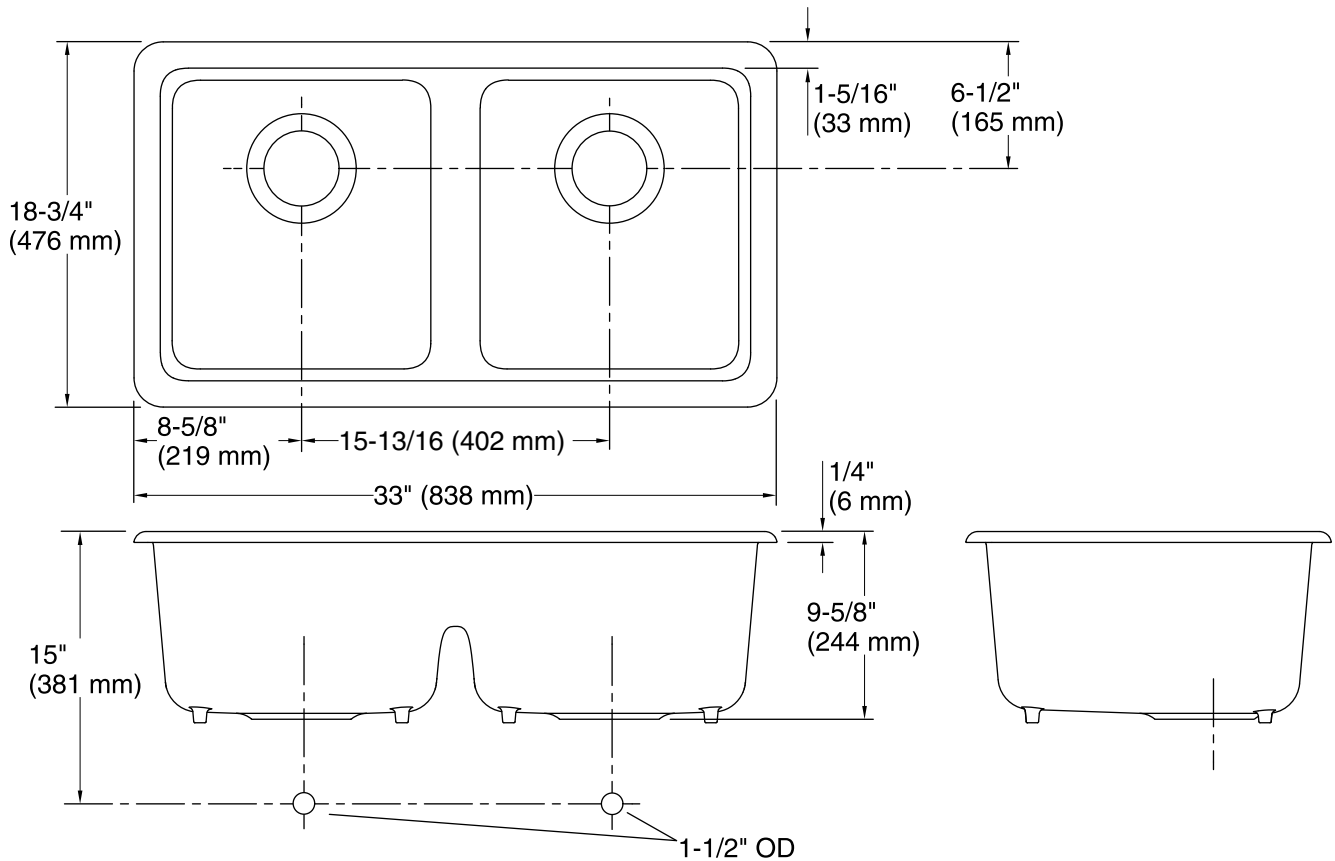

Technical Information

All product dimensions are nominal.

Installation:	Under-mount, Top-mount
Min. base cabinet width:	36" (914 mm)
Bowl area:	Length: 30-5/16" (770 mm) Width: 16-1/16" (408 mm) Bowl depth: 9" (229 mm) Water depth: 9" (229 mm)
Drain hole:	3-7/8" (98 mm)
Template:	1043168-7, required, included

Notes

Install this product according to the installation instructions.

Countertop manufacturer or cutter must use the cut-out template provided with the product, or a current one provided by Kohler Co. (call 1-800-43-FOCUS). Kohler Co. is not responsible for cut-out errors when the incorrect cut-out template is used.