



# Glen Falls™

## Top-/Under-Mount Utility Sink

### K-19017-3

#### Features

- Fits minimum 27-inch base cabinet if installed as top-mount or under-mount.
- Single bowl.
- 13-inch depth provides generous workspace.
- Three faucet holes.

#### Material

- KOHLER® enameled cast iron.

#### Installation

- Dual-mount sink can be installed as top-mount or under-mount.
- Under-mount installation kit not included.

#### Recommended Products/Accessories

- K-9000 P-Trap
- K-8801 Sink Strainer
- K-8799 Sink Strainer



#### Codes/Standards







ASME A112.19.1/CSA B45.2

#### KOHLER® Enameled Cast Iron Kitchen Sink Lifetime Limited Warranty

See website for detailed warranty information.

#### Available Colors/Finishes

*Color tiles intended for reference only.*

| Color  | Code | Description  |
|--|------|--------------|
|  | 0    | White        |
|  | FF   | Sea Salt™    |
|  | 96   | Biscuit      |
|  | 47   | Almond       |
|  | 95   | Ice™ Grey    |
|  | 7    | Black Black™ |

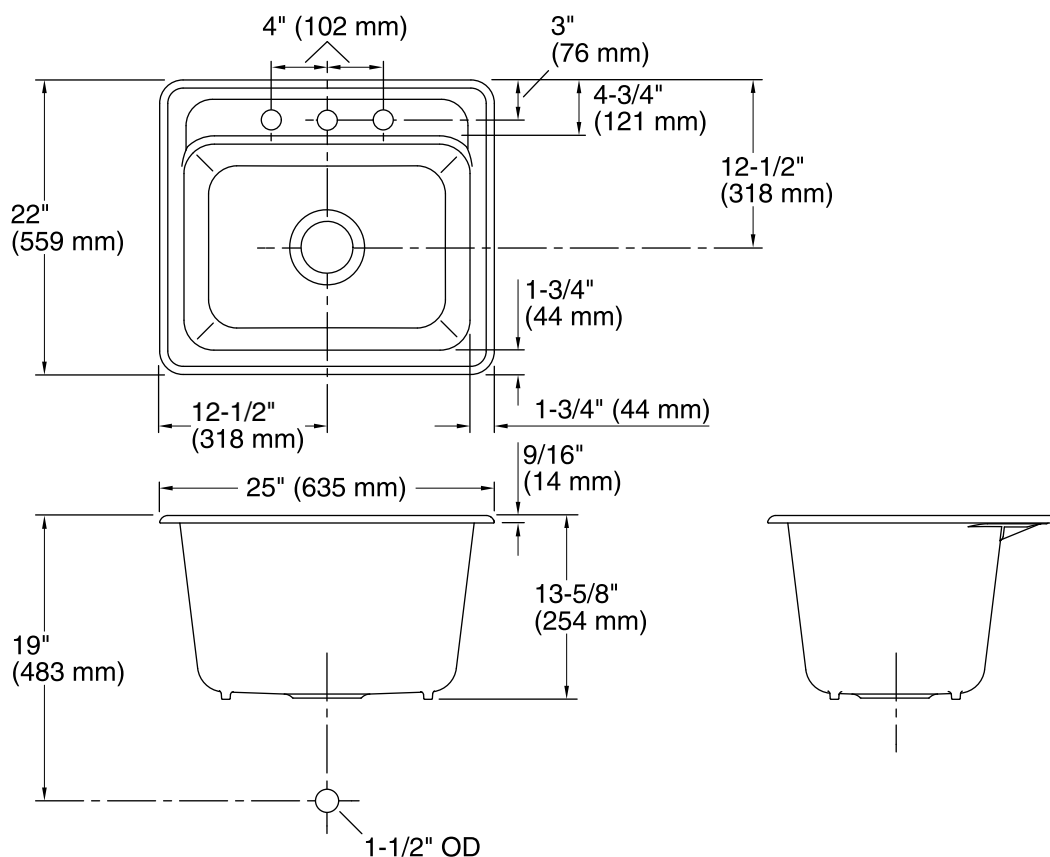

### Technical Information

All product dimensions are nominal.

|                          |  |
|--------------------------|--|
| Bowl configuration:      | Single   |
| Installation:            | Top-mount, Under-mount   |
| Min. base cabinet width: | 27" (686 mm)   |
| Bowl area (Only):        | Length: 21-1/2" (546 mm)<br>Width: 15-1/2" (394 mm)<br>Bowl depth: 13" (330 mm)<br>Water depth: 13" (330 mm) |
| Number of deck holes:    | 3  |
| Faucet hole(s):          | 1-3/8" (35 mm)   |
| Drain hole:              | 3-7/8" (98 mm)   |
| Template:                | 1079983-7, required, included  |

### Notes

Install this product according to the installation instructions.